

TS 4000
TS 4000 S



107754-04



A

B

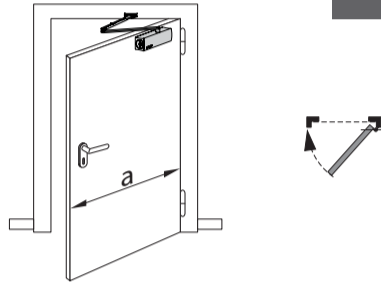
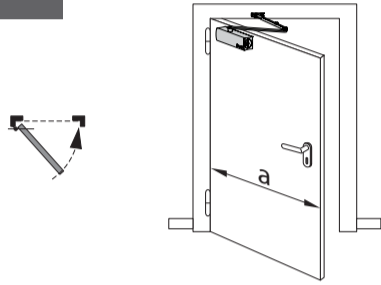

TS 4000/4000 S $a \leq 1400$ mm
TS 4000 EN 5-7 $a \leq 1600$ mm

TS 4000/4000 S $a \leq 1400$ mm
TS 4000 EN 5-7 $a \leq 1600$ mm

1

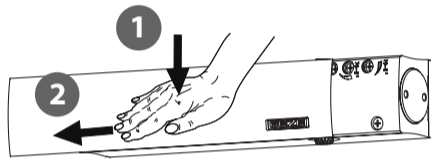

2

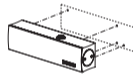
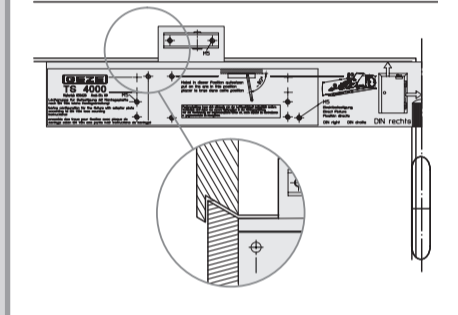
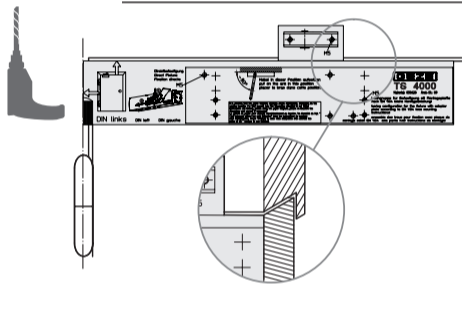

[mm]

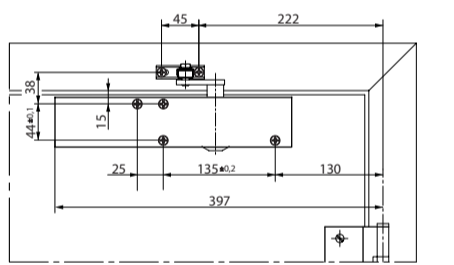
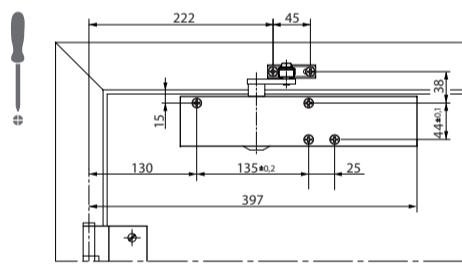

4x
5x60
4x
M5x55

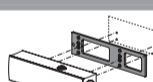

[mm]

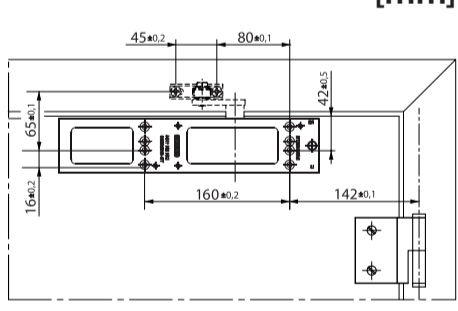
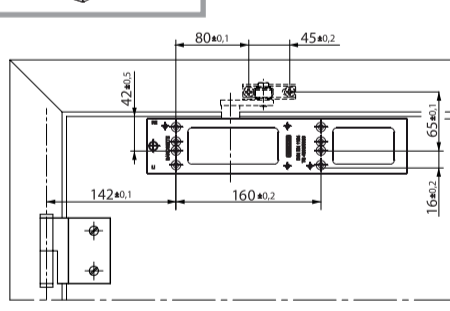

4x
5x35
4x
M5x20

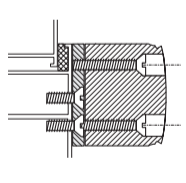
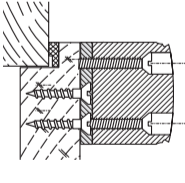

3x
M5x45

3

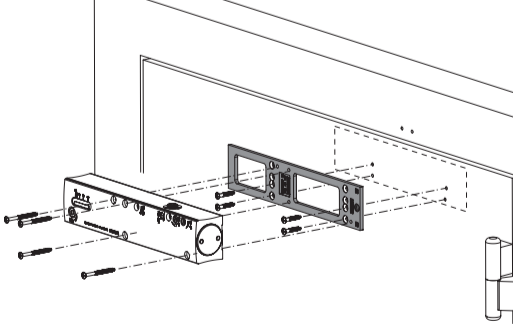
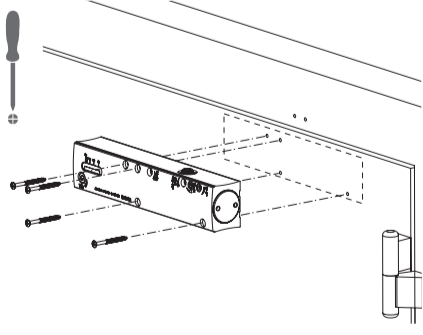

4

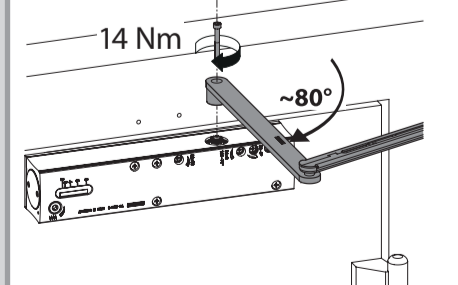
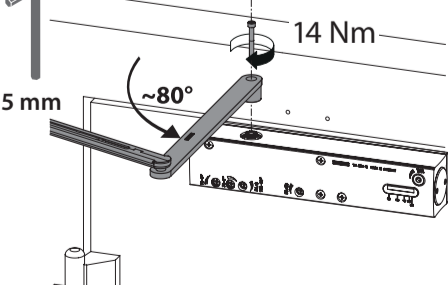

5

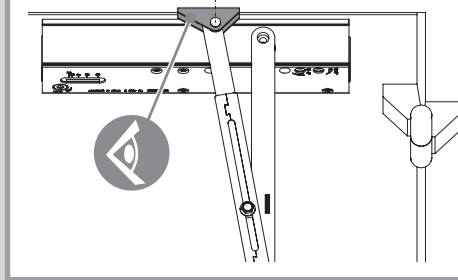
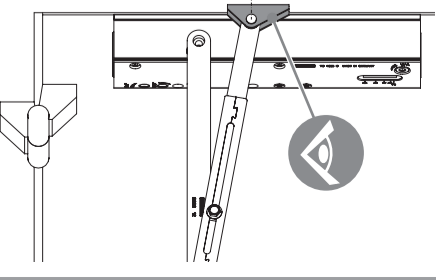

6



10 mm

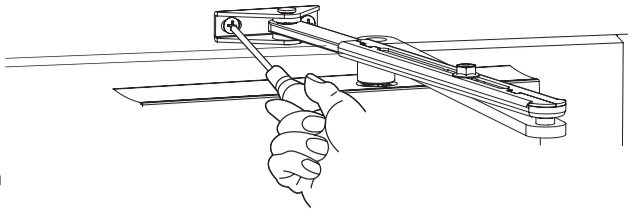

- 2x 5x20
- 2x M5x16

i+

TS 4000

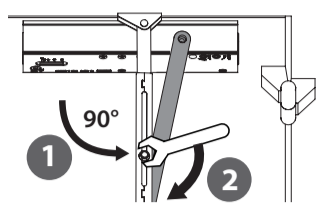
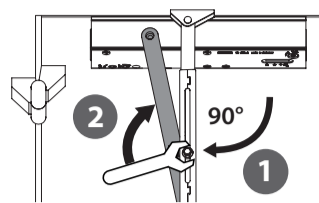
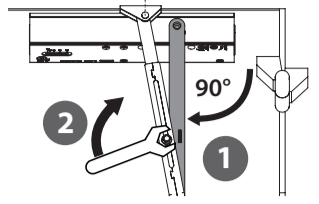
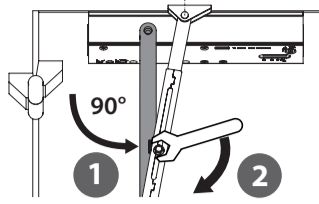
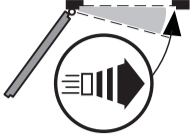

i+

TS 4000 S

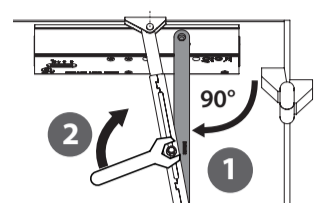
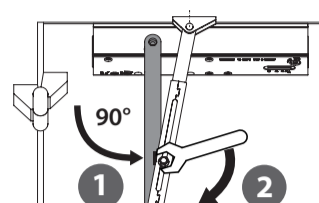

7



5 mm

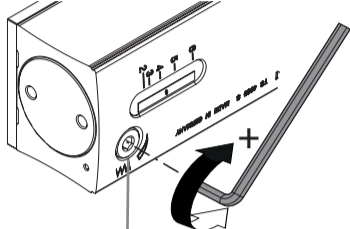
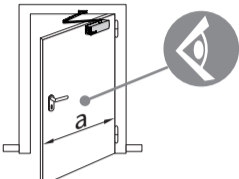

a (mm) - EN

1600	- 7
1400	- 6
1250	- 5
1150	- 4
950	- 3
850	- 2
750	- 1

(*) = + ≥ EN 3

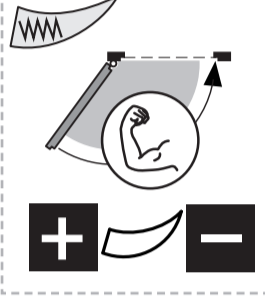

8

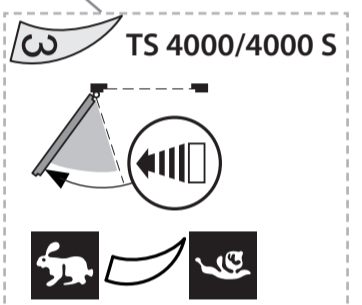
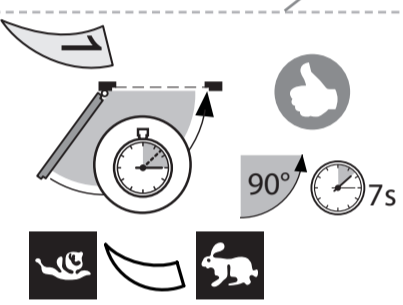

i+

TS 4000 S

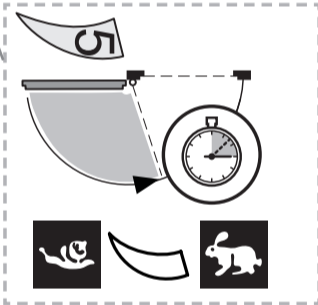
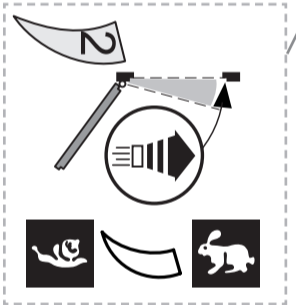

9

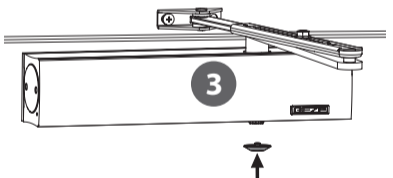
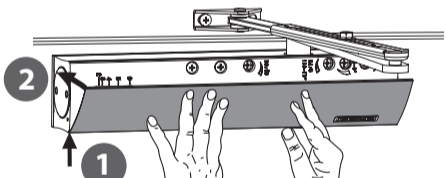

i

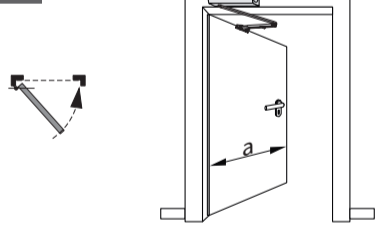

TS 4000/4000 S a ≤ 1400 mm
 TS 4000 EN 5-7 a ≤ 1600 mm

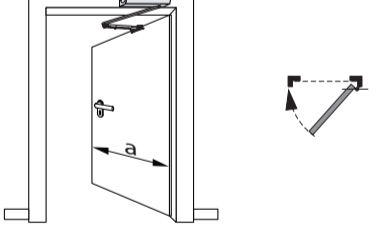

TS 4000/4000 S a ≤ 1400 mm
 TS 4000 EN 5-7 a ≤ 1600 mm

